

## ALUTRUSS QUADLOCK 6082-1500 4-Way Cross Beam

4-point truss system

Art. No.: 60306508

GTIN: 4026397501421

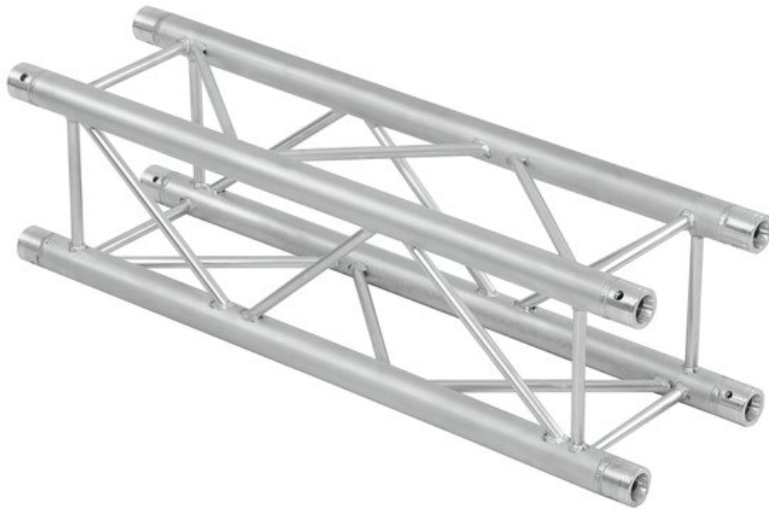

**List price: 284.41 €**

incl. 19% VAT.

### Description:

#### QUADLOCK 6082 4-point truss system

QUADLOCK 6082 is a 4-point truss system made of aluminum. The individual elements are connected via four cones, pivots and pins. QUADLOCK 6082 is made of EN-AW 6082 T6 (AlMgSi1 T6) alloy for even higher loads.

The advantage of the conical connection system is that the cones completely fit into the main chords so that highest load capacity is guaranteed. The Quick-Lock system enables fast, efficient and highly aesthetic assembly when the truss constructions are frequently assembled and dismantled.

The four main chords are made of 50 mm aluminum tube with 2 mm wall thickness and offer a good relation between strength and weight. The braces have a diameter of 16 mm with 2 mm wall thickness and leave enough space for installing couplers, hooks and clamps.

With 290 mm outer dimensions, QUADLOCK QQTR is a stable truss system for higher loads and extended durability. This system is mainly designed for intense use in stage installations, fair installations, event installations but also for permanent installations in discotheques and theatres.

Its polished surface makes this universal system a real eyecatcher. Due to its wide range of standard system lengths, corners and accessory, this system is highly versatile and offers unlimited design possibilities.

The production of this truss system is TUV-monitored. The load table as calculation base can be downloaded from the Internet before buying the product!

Please note: this truss system must never be combined with other systems!

### Logistic

EAN / GTIN: 4026397501421

Weight: 10,15 kg

Length: 1.52 m

Width: 0.30 m

Height: 0.30 m

Bulky product

## Features:

---

- Strong EN-AW 6082 alloy for high loads
- High-quality aluminum-tubes with 50 mm in diameter
- Low weight
- Distance center - center: 240 mm
- Easy installation
- Trusspipe: 50 mm
- TÜV Süd certified
- For application areas such as: Theater; Trade fair and shop fitting; Clubs/dancing school
- For further information about this product, please refer to the Data Sheet under "Downloads"

### Package contents

- 1 x connection Set

## Technical specifications:

---

Setup:	Easy installation
Trusspipe:	50 mm x 2 mm
Welding technique:	TIG-welding
Welding material:	AlMg 5
Alloy:	AlMgSi1 T6
Color:	Alu colored
Strut diameter x thickness:	16 x 2mm
Dimensions:	Length: 1,5 m Width: 29 cm Height: 29 cm
Weight:	8,90 kg